

# ZETA 2.3"-Pendant

Spec-grade | Architectural LED Linear Lighting



OKT Zeta series 2.3" linear pendant lighting is a unique linear series that brings any space to the center stage. These timeless, streamlined forms blend well with contemporary decors and modern workplaces. These linear luminaries is available in 2ft, 3ft, 4ft and 8ft, simply provide wide, powerful lighting to any atmosphere with continuous runs. It can provide smooth uplight and downlight, allowing for wider spacing between fixtures and better ceiling light uniformity. Unleash lighting design flexibility with Zeta with different shapes and patterns, it adds fun factor into each room. These creations will let you suggest rhythm, communicate meaning and showcase element of life.

## Feature

- Wattage selectable (50%/75%/100%)
- CCT adjustable from 3000K, 3500K, 4000K
- 7 embedded lighting distributions adjusting by dip switch
- Available in diffuser, micro reflector, louver and deep regressed lens
- Available in 2', 3', 4' and 8', individual units or continuous runs
- Custom pattern with optional Line, L, X, T, Y, V, Z joiners

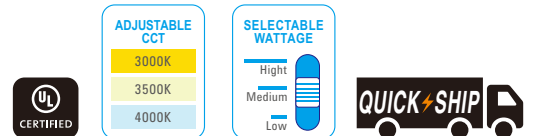
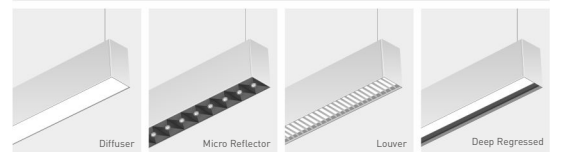

## PERFORMANCE

Lens	Lumen Package		
	High	Medium	Low
Diffuser	1150lm/ft, 10w/ft	860lm/ft, 7.5w/ft	575lm/ft, 5w/ft
Louver	900lm/ft, 10w/ft	675lm/ft, 7.5w/ft	450lm/ft, 5w/ft
Micro Reflector	1150lm/ft, 10w/ft	860lm/ft, 7.5w/ft	575lm/ft, 5w/ft
Deep Regressed	950lm/ft, 10w/ft	710lm/ft, 7.5w/ft	475lm/ft, 5w/ft

Remark:  
Micro reflector is single CCT, rather than CCT adjustable. 3500K and 4000K are available Quickship service.  
Above are subject to 3500K. All efficacy is ±5% base on different CCT. Check the IES file to gain the accurate data.

# ZETA 2.3"-Pendant

Spec-grade | Architectural LED Linear Lighting



## PRODUCT PERFORMANCE

### ► Optics

It offers a selection of professional lens such as diffuser, louver, micro reflector and deep regressed lens to meet your different requires.

### ► Finish

- Extruded aluminum housing.
- Powder coat white and black finish or custom.

### ► Electrical

LED Driver	It is powered by Class 2 high efficiency LED driver, with a standard 1-10V dimming which continuous dims to 10% that works with many types of controls. Tested Dimmers: Lutron @ Diva-Dvtv, Leviton @ IP-710-DL.
THD	<20%
Power Factor	>0.9
Input Voltage	Standard electronic drivers are cULus recognized and available for 110-277V or 110-347V*AC

### ► Mounting

- Pendant-Dry ceiling or T-Grid ceiling compatible. Cable lengths of 5ft is standard, 12ft or others are available
- Individual or continuous run, up to 40ft in 120VAC, 100ft in 277VAC
- Custom Pattern with optional Line, L, X, T, V, Y, Z joiners.

### ► LED System

CRI	Minimum 80 color rendering index
CCT	CCT adjustable from 3000K,3500K and 4000K.
Environment	Damp rated for ambient operating temperature of -20°C to +40°C (-4° to+104°F)

### ► Approvals

- cULus listed for damp locations
- 5 years limited warranty

## PRODUCT ORDERING GUIDE

Default Settings :Maximum wattage, 4000K and 100% down.

### Sample

$\frac{ZE}{1} - \frac{2}{23} - \frac{I}{4} \frac{TW}{5} \frac{A}{6} \frac{D}{7}$

<input type="checkbox"/> ZE	-	<input type="checkbox"/>	-	<input type="checkbox"/> 2	-	<input type="checkbox"/> I	<input type="checkbox"/> TW	<input type="checkbox"/> A	<input type="checkbox"/>
1		2		3		4	5	6	7

### 1. Base Model

ZE ZETA

### 2. Length

2 2 feet  3 3 feet\*  4 4 feet  8 8 feet

### 3. Width

2 2.3 inch

### 4. Driver

I Internal

### 5. CCT

<input type="checkbox"/> TW Diffuser/Louver/Regressed CCT Adjustable (3000K,3500K,4000K)	<input type="checkbox"/> Micro reflector <input type="checkbox"/> 30 3000K* <input type="checkbox"/> 35 3500K <input type="checkbox"/> 40 4000K
---	--

### 6. Light Distribution

A Following options available by dip switch  
100% Uplight 10% down, 90% up 30% down, 70% up  
50% down, 50% up 70% down, 30% up 90% down, 10% up  
100% Downlight

### 7. Optics Options

<input type="checkbox"/> D Diffuser	<input type="checkbox"/> R Micro Reflector
<input type="checkbox"/> L Louver	<input type="checkbox"/> T Deep Regressed

## OPTIONAL ORDERING GUIDE

### Ceiling Type

Dry Wall (Mount to J-box)  
 Drop Ceiling Clips (Suitable for 9/16" and 15/16" Flat Ceiling)  
 Drop Ceiling Clips (Suitable for 9/16" Slot Ceiling)  
 Drop Ceiling Clips (Suitable for 15/16" Slot Ceiling) \*

### Power Cord Length And Aircraft cable

5 ft white power cord + 5ft aircraft cable  
 5 ft black power cord + 5ft aircraft cable  
 12 ft white power cord + 12ft aircraft cable  
 12 ft black power cord + 12ft aircraft cable

### Canopy

Finish:  White  Black  
Type:  1.6" Round  4.5" Round (Designed for power cable)  
 1.6" Square  4.5" Square (Designed for power cable)  
 5.8" Round With Occupancy Sensor (Power Feed)

### Joiner

<input type="checkbox"/> "-" pattern	<input type="checkbox"/> Rolling Diffuser (42')	<input type="checkbox"/> "X" pattern
<input type="checkbox"/> "Y" pattern	<input type="checkbox"/> "L" pattern	<input type="checkbox"/> "V" pattern *
<input type="checkbox"/> "T" pattern	<input type="checkbox"/> "Z" pattern	

### Optional Functions

Occupancy Sensor (Order Separated)  
 Emergency Option  
 Built-in LED Emergency Driver  Order Separated LED Emergency Driver

\*Additional cost and/or lead time on customized fixtures may apply. Some fixtures require an MOQ. Please contact your sales rep for more information.

## MOUNTING

### Canopy Style

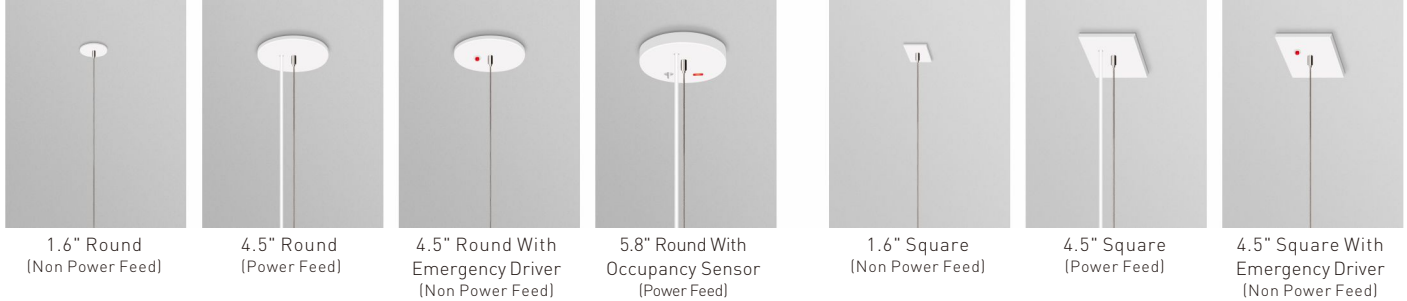

### Dry Ceiling / Off Grid

"Various Hard Ceilings" (Mount to J-box)

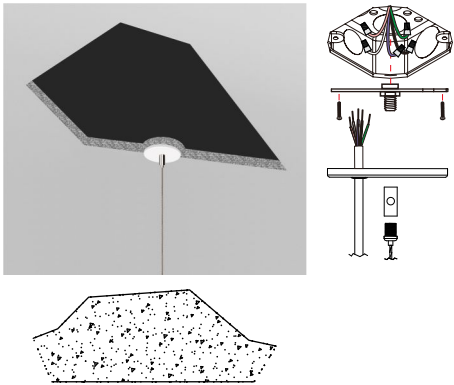

### Drop Ceiling / On Grid

Suspending the luminaire in the T-grid. Compatible for various T-grid, including 9/16" Flat, 9/16" Slot, 15/16" Flat.

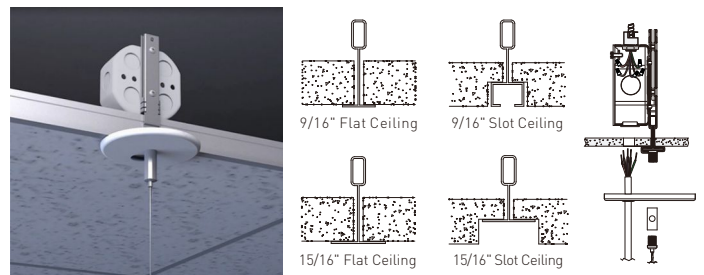

\*Please see the installation instruction for more details.

### Pendant Accessories For Dry Ceiling

#### Canopy Kits



#### Power Cord Kits



#### Aircraft Cable Kits



### Pendant Accessories For Drop Ceiling

#### Canopy Kits



#### Power Cord Kits



#### T-grid Clips



#### Junction Box



#### Aircraft Cable Kits



# ZETA 2.3"-Pendant

Spec-grade | Architectural LED Linear Lighting



## Standard Line Runs In 120V

Luminaire Run Length (ft)	Run Configuration	Line Joiner	5' Power Cable	5' Aircraft Cable	Canopy
2	2'	-	1	2	2
4	4'	-	1	2	2
6	4'+2'	1	1	3	3
8	8'	-	1	2	2
10	8'+2'	1	1	3	3
12	8'+4'	1	1	3	3
14	8'+4'+2'	2	1	4	4
16	8'+8'	1	1	3	3
18	8'+8'+2'	2	1	4	4
20	8'+8'+4'	2	1	4	4
22	8'+8'+4'+2'	3	1	5	5
24	8'+8'+8'	2	1	4	4
26	8'+8'+8'+2'	3	1	5	5
28	8'+8'+8'+4'	3	1	5	5
30	8'+8'+8'+4'+2'	4	1	6	6
32	8'+8'+8'+8'	3	1	5	5
34	8'+8'+8'+8'+2'	4	1	6	6
36	8'+8'+8'+8'+4'	4	1	6	6
38	8'+8'+8'+8'+4'+2'	5	1	7	7
40	8'+8'+8'+8'+8'	4	1	6	6
42	8'+8'+8'+8'+8'+2'	5	2	7	7

### Individual

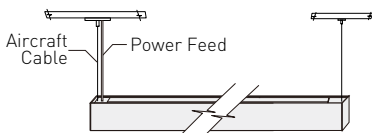

### Continuous Run

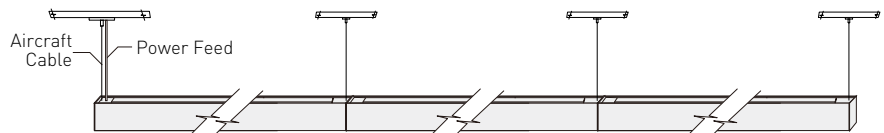

120VAC: Connections up to 40ft.  
277VAC: Connections up to 100ft.

### Custom Pattern With Joiners

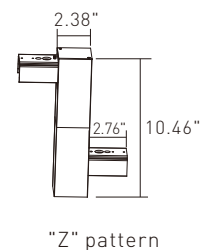
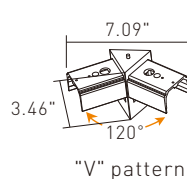
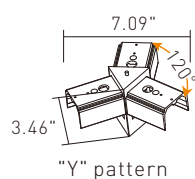
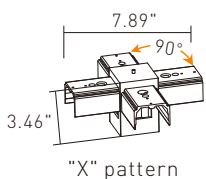
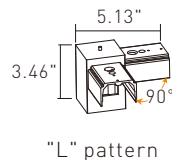
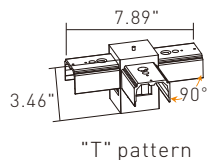
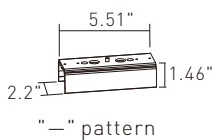

# ZETA 2.3"-Pendant

Spec-grade | Architectural LED Linear Lighting



## Mounting Location

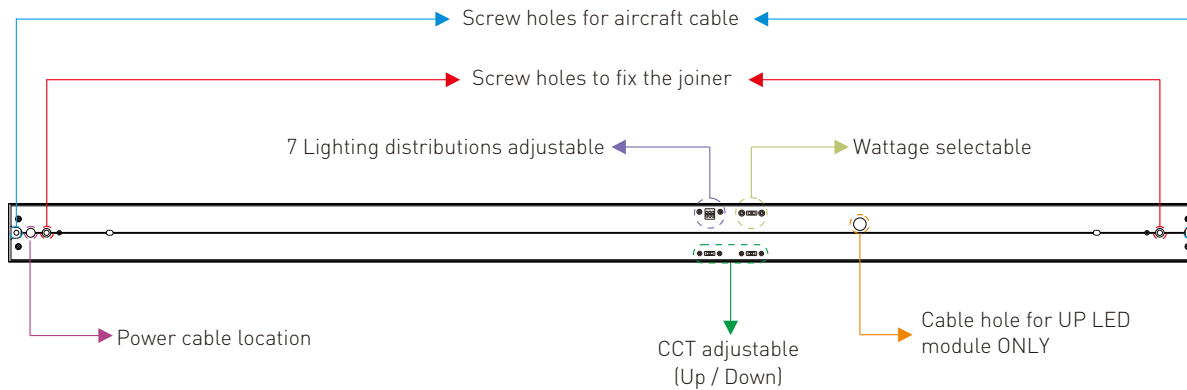

## DIMENSIONS

### Micro Reflector and Louver

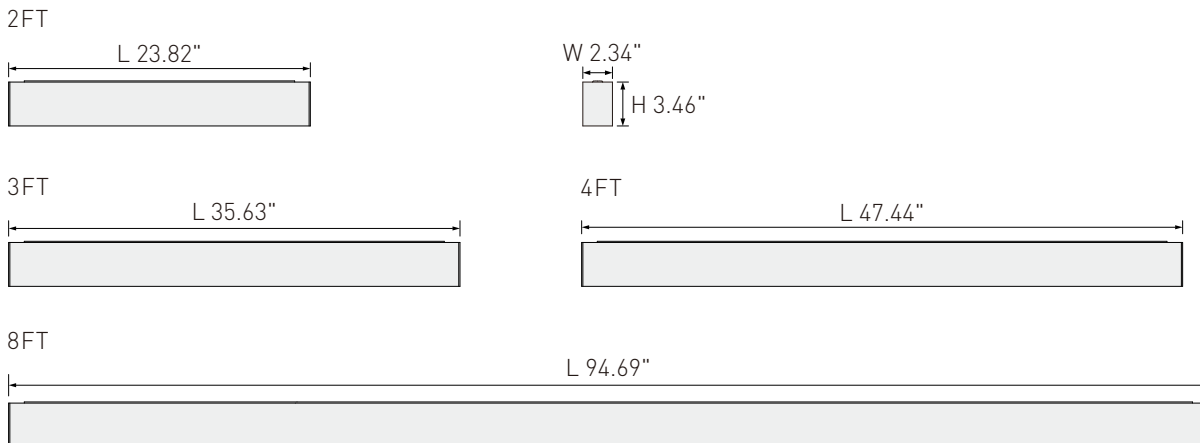

### Diffuser and Deep Regressed

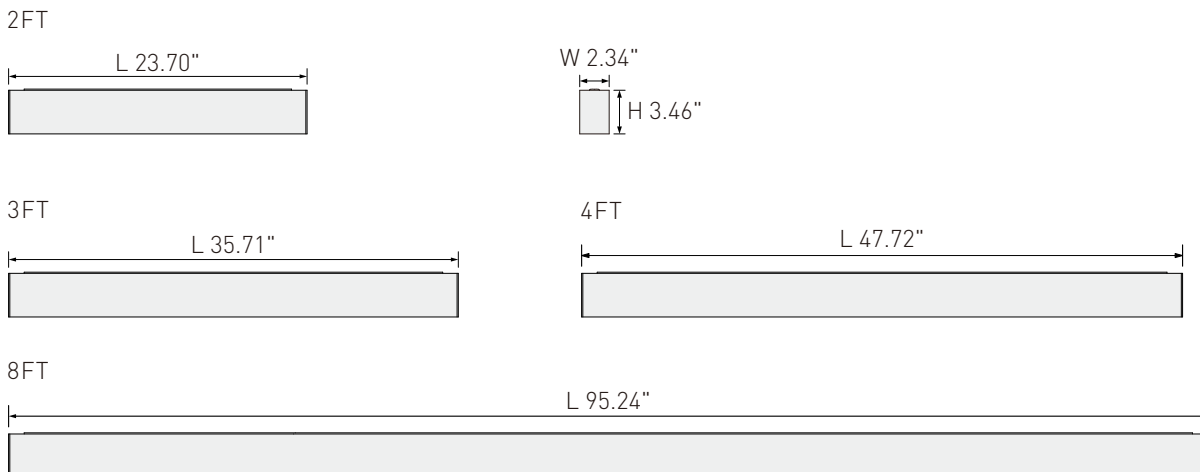

# ZETA 2.3"-Pendant

Spec-grade | Architectural LED Linear Lighting



## OPTIONAL FUNCTION

### ► Emergency Option

OKT Lighting offers UL& CEC Listed LED emergency drivers. They could be factory installed or field installed. When AC power fails it, immediately switches to the emergency mode operating for lighting minimum 90 minutes. When AC power is restored it, automatically returns to the charging mode which meets critical life-safety lighting requirements.

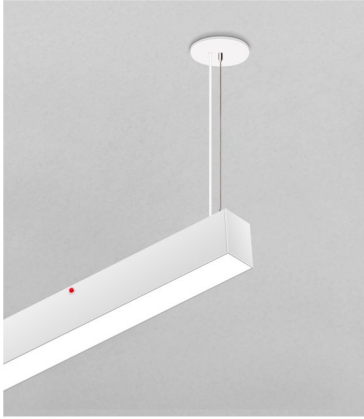

#### Built-in LED emergency driver

OKT Lighting offers the LED luminaire with built-in 8w LED emergency driver to provide critical illumination when normal power fails for any reason. It can save your labor cost with simple wiring.

#### Specification For LED Emergency Driver

Output Power	8 Watts
Output Voltage	15-54V DC
Input Current	70 mA (Max)
Input Power	3.2 Watts (Max)
Input Voltage	110-277VAC, 50-60Hz
Emergency Operation	≥90 Minutes
Standby Power	< 0.4W
Operating Temp	0°C to 50°C
Battery	Lithium
Recharge	24 Hrs
Certificate	UL , CEC

#### Code-Required Testing

##### • Initial Self-Test After Installation

It will perform a functional test in 3 seconds after the driver installed to check the wiring and battery output when work. The indicator LED will be off or flicker in case of a failure or an error.

##### • Second Self-Test In 120 Minutes

It will perform second test in 120 minutes to check again. Upgrade in Gen 3: Repeat 4 times in every 120 minutes if fail in the second test.

##### • Monthly Self-Test

It will automatically perform a test every 30 days with a duration of 3 seconds, in which the wiring and battery output are checked. In case of a failure or an error, the indicator LED will be off or flicker.



#### Order Separated LED emergency driver

Optional 8w or 25w high voltage LED emergency driver can be provided if you need and do it wiring in field. For more info or spec sheet please visit our, website or contact sales.



### ► Occupancy Sensor



We can provide a factory-installed integrated sensor system for multi-level control based on motion and/or daylight contribution with BR1810-B-D level & daylight harvest microwave sensor from SHARKWARD. For more info or spec sheet, please contact sales.

#### Specification

Power Supply	120/277 VAC 50/60Hz
Maximum load @ (-40°F~+158°F (-40°C~+70°C))	Resistive/ Tungsten-600W@120V Electronic Ballast(LED)-800VA@120V/1200VA@277V
HF System	5.8GHz CW
Dim Control Output	0-10V, max.25mA sinking current
Detection Radius/angle	Max 26ft.(8m)/360
Mounting Height	Max 12ft
Humidity	Max.95% RH
Temperature	-40°F~+158°F (-40°C~+70°C)

#### Sensor Coverage

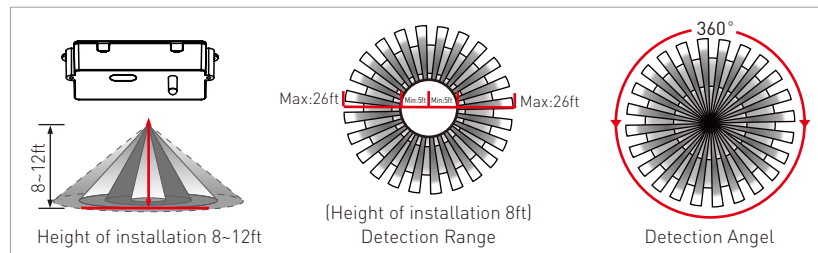

# ZETA 2.3"-Pendant

Spec-grade | Architectural LED Linear Lighting



## DISTRIBUTION DIAGRAM

4' / Diffuser/50% Up,50% Down/ 4000K

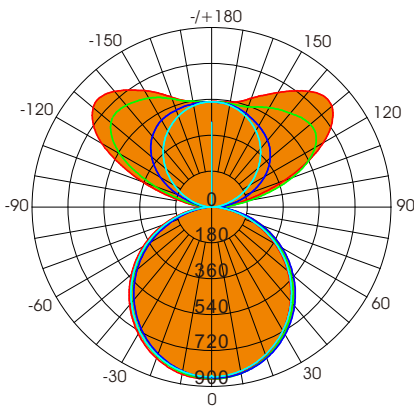

Test Number: ZE-42-I40AD  
 Lumens: 4739.1 Lm  
 Watts: 40 W  
 LPW: 118.48 Lm/W  
 CCT: 4000K

UNIT: cd  
 — C0/180, 360°  
 — C30/270, 360°  
 — C60/240, 360°  
 — C90/270, 360°

### Zonal Flux Diagram

τ	C0	C45	C90	C135	C180
5	857.7	858.1	847.3	841.0	861.4
10	844.1	849.1	835.1	821.8	851.1
15	822.1	831.6	815.6	795.4	833.5
20	792.8	807.2	788.8	762.5	807.4
25	757.1	775.5	755.5	723.0	774.6
30	716.2	737.2	715.9	677.7	735.6
35	667.9	693.4	670.2	627.5	690.3
40	616.1	644.0	619.9	572.8	639.9
45	559.4	589.1	564.3	513.7	585.0
50	499.2	530.9	505.0	451.3	525.8
55	434.1	468.3	441.5	385.1	462.7
60	365.3	402.1	374.7	315.6	395.8
65	295.4	332.9	305.0	244.5	326.8
70	224.4	260.6	232.0	174.7	254.3
75	154.3	189.1	161.3	108.6	184.1
80	90.07	120.5	95.53	51.77	117.0
85	36.95	60.98	41.01	10.68	58.12
90	39.69	49.44	5.334	21.91	41.89
95	85.06	88.27	21.25	52.16	75.79
100	151.2	163.7	51.22	102.9	136.5
105	253.3	249.8	89.41	186.2	230.4
110	384.4	328.2	131.1	278.8	362.9
115	522.2	393.5	175.2	367.8	502.4
120	647.4	443.0	219.3	441.8	634.5
125	736.9	476.4	263.0	496.2	724.5
130	787.6	497.4	305.2	530.7	775.5
135	790.8	509.9	345.3	550.9	783.9
140	758.4	518.4	382.3	561.8	757.7
145	711.4	519.9	415.5	567.2	716.9
150	663.4	517.6	443.7	564.1	675.3
155	619.4	514.2	468.7	554.3	630.8
160	581.3	514.0	489.8	540.6	586.6
165	549.4	519.6	506.9	535.1	554.4
170	534.3	524.9	518.7	530.1	537.2
175	531.2	528.0	526.1	528.6	529.6
180	529.9	529.8	529.8	529.8	529.9
DEG	LUMINOUS INTENSITY:cd				

### Zonal Lumens

τ	φ total
0-5	20.42
5-10	80.98
10-15	179.6
15-20	312.7
20-25	475.8
25-30	663.4
30-35	869.1
35-40	1086
40-45	1307
45-50	1525
50-55	1733
55-60	1924
60-65	2092
65-70	2230
70-75	2336
75-80	2408
80-85	2448
85-90	2466
90-95	2489
95-100	2533
100-105	2611
105-110	2730
110-115	2888
115-120	3081
120-125	3295
125-130	3517
130-135	3735
135-140	3940
140-145	4125
145-150	4287
150-155	4426
155-160	4539
160-165	4626
165-170	4689
170-175	4726
175-180	4739
	UNIT: lm

### Luminance cd/(m2)

G(DEG)	C0/180	C90/270
85	5888	6535
80	7204	7641
75	8283	8654
70	9112	9422
65	9708	10024
60	10148	10409
55	10512	10690
50	10787	10912
45	10988	11085

# ZETA 2.3"-Pendant

Spec-grade | Architectural LED Linear Lighting



## DISTRIBUTION DIAGRAM

4'/Louver/50% Up,50% Down/ 4000K

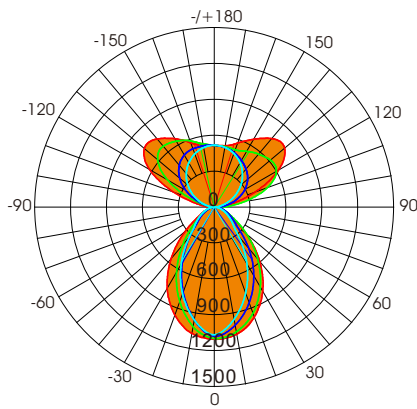

AVERAGE BEAM ANGLE(50%): 191.7°

Test Number: ZE-42-I40AL  
 Lumens: 3865.5 Lm  
 Watts: 40 W  
 LPW: 96.64 Lm/W  
 CCT: 4000K

UNIT: cd  
 — C0/180, 324.8°  
 — C30/270, 314.8°  
 — C60/240, 65.6°  
 — C90/270, 61.7°

### Zonal Flux Diagram

τ	C0	C45	C90	C135	C180
5	1100	1077	1028	1015	1096
10	1080	1035	954.1	927.2	1072
15	1041	977.1	866.4	828.8	1028
20	979.0	906.2	768.3	723.1	961.9
25	903.0	823.8	661.9	612.2	881.6
30	812.0	730.3	548.8	499.4	787.4
35	706.6	628.1	432.8	390.0	679.1
40	591.3	522.4	316.4	290.5	560.6
45	471.1	417.4	235.2	206.1	439.0
50	351.7	316.7	194.1	152.0	319.5
55	244.0	231.3	158.3	115.4	215.3
60	160.0	176.7	126.5	85.60	138.9
65	117.8	138.1	98.45	60.39	105.0
70	83.27	105.6	73.47	38.44	73.07
75	55.29	77.53	51.06	19.18	46.75
80	32.44	53.30	31.05	2.405	25.50
85	13.97	49.71	13.08	0.4994	7.709
90	29.54	66.04	1.446	0.4677	28.35
95	70.36	110.9	14.68	27.90	68.82
100	133.0	190.9	43.89	68.63	129.1
105	228.5	270.2	80.50	137.4	223.0
110	355.3	337.7	121.1	230.3	353.8
115	492.0	391.6	164.4	234.5	492.5
120	619.5	430.1	208.1	409.1	623.0
125	713.4	455.4	251.6	474.8	712.6
130	768.4	471.2	292.9	520.3	762.4
135	777.3	482.8	332.0	546.0	769.7
140	748.7	488.8	368.7	559.9	743.5
145	702.6	489.1	402.4	567.3	703.2
150	654.4	489.0	431.7	567.4	661.0
155	609.5	490.4	456.6	557.6	615.5
160	570.4	497.4	477.9	544.6	571.4
165	537.7	505.0	495.6	530.6	539.5
170	521.3	510.4	508.1	524.3	523.3
175	517.3	513.0	515.4	517.9	516.2
180	516.7	516.6	516.5	516.6	516.7
DEG	LUMINOUS INTENSITY:cd				

### Zonal Lumens

τ	φ total
0-5	25.57
5-10	99.25
10-15	214.1
15-20	361.0
20-25	529.2
25-30	707.3
30-35	883.4
35-40	1047
40-45	1189
45-50	1308
50-55	1405
55-60	1483
60-65	1543
65-70	1590
70-75	1624
75-80	1647
80-85	1660
85-90	1672
90-95	1692
95-100	1734
100-105	1808
105-110	1919
110-115	2069
115-120	2252
120-125	2457
125-130	2672
130-135	2883
135-140	3082
140-145	3263
145-150	3422
150-155	3558
155-160	3669
160-165	3755
165-170	3816
170-175	3853
175-180	3866
	UNIT: lm

### Luminance cd/(m2)

G(DEG)	C0/180	C90/270
85	2227	2085
80	2595	2483
75	2967	2740
70	3381	2983
65	3871	3236
60	4444	3513
55	5907	3834
50	7599	4195
45	9253	4620



# ZETA 2.3"-Pendant

Spec-grade | Architectural LED Linear Lighting



## DISTRIBUTION DIAGRAM

4'/Micro Reflector/50% Up,50% Down/ 4000K

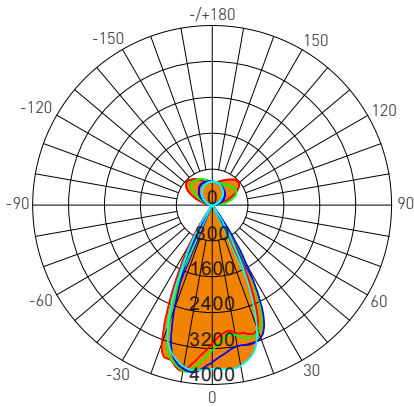

AVERAGE BEAM ANGLE(50%): 51.1°

Test Number: ZE-42-I40AR  
 Lumens: 4530.0 Lm  
 Watts: 40 W  
 LPW: 113.25 Lm/W  
 CCT: 4000K

UNIT: cd  
 — C0/180, 51.8°  
 — C30/270, 51.9°  
 — C60/240, 51.1°  
 — C90/270, 49.5°

### Zonal Flux Diagram

τ	C0	C45	C90	C135	C180
5	2868	3126	3668	3715	3397
10	2880	3036	3634	3615	3745
15	2965	3158	3455	2948	3584
20	2939	3141	2911	1757	3294
25	2099	2754	1812	787.4	2093
30	819.2	1675	767.6	84.95	1038
35	57.67	519.7	112.1	5.340	215.8
40	5.200	38.70	6.196	3.696	5.573
45	3.849	4.987	2.988	2.833	3.959
50	2.820	3.517	1.928	1.993	3.010
55	2.048	2.444	1.189	1.486	2.168
60	1.700	1.590	0.8656	1.277	1.783
65	1.470	1.073	0.7377	1.168	1.502
70	1.244	0.8401	0.6042	0.9728	1.231
75	0.9286	0.6696	0.5020	0.8287	0.9745
80	0.6716	0.5905	0.3831	0.7114	0.7084
85	0.5373	29.27	0.2523	0.4937	0.5233
90	30.98	71.66	0.2141	0.0995	29.17
95	75.71	141.9	15.05	24.16	67.03
100	142.1	225.0	44.13	62.52	127.1
105	242.7	301.3	80.91	126.9	220.4
110	372.9	363.9	121.7	217.7	351.7
115	510.1	410.7	165.2	310.7	490.8
120	635.7	442.3	209.3	395.6	622.1
125	724.8	462.4	252.9	463.4	710.8
130	775.0	475.8	294.3	511.7	761.3
135	779.1	483.6	333.9	540.5	769.3
140	747.9	487.4	371.4	557.4	744.0
145	702.3	487.4	407.0	568.1	704.9
150	655.7	488.6	438.3	571.1	664.9
155	612.7	494.3	464.0	564.6	620.9
160	575.3	503.6	486.8	554.1	577.9
165	544.1	512.1	505.8	540.0	547.0
170	529.8	517.2	519.4	534.1	531.5
175	527.0	523.3	527.4	527.4	525.0
180	526.1	525.7	525.2	525.2	526.1
DEG	LUMINOUS INTENSITY:cd				

### Zonal Lumens

τ	φ total
0-5	82.46
5-10	328.5
10-15	726.1
15-20	1229
20-25	1728
25-30	2096
30-35	2265
35-40	2302
40-45	2306
45-50	2307
50-55	2308
55-60	2309
60-65	2310
65-70	2310
70-75	2311
75-80	2311
80-85	2313
85-90	2320
90-95	2342
95-100	2386
100-105	2463
105-110	2576
110-115	2727
115-120	2909
120-125	3113
125-130	3327
130-135	3538
135-140	3737
140-145	3919
145-150	4079
150-155	4216
155-160	4329
160-165	4417
165-170	4480
170-175	4517
175-180	4530
	UNIT: lm

### Luminance cd/(m2)

G(DEG)	C0/180	C90/270
85	86	40
80	54	31
75	50	27
70	50	25
65	48	24
60	47	24
55	50	29
50	61	42
45	76	59

# ZETA 2.3"-Pendant

Spec-grade | Architectural LED Linear Lighting



## DISTRIBUTION DIAGRAM

4'/Deep Regressed/50% Up,50% Down/ 4000K

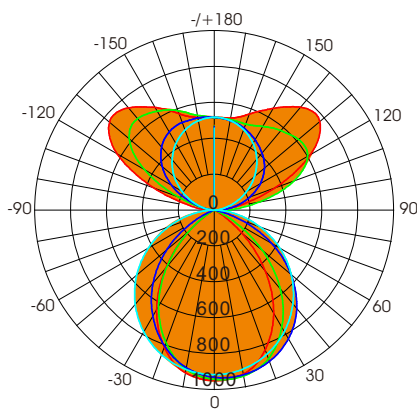

Test Number: ZE-42-140AT  
 Lumens: 4070.6 Lm  
 Watts: 40 W  
 LPW: 101.77 Lm/W  
 CCT: 4000K

UNIT: cd  
 — C0/180, 360°  
 — C30/270, 360°  
 — C60/240, 360°  
 — C90/270, 360°

### Zonal Flux Diagram

τ	C0	C45	C90	C135	C180
5	946.0	943.5	913.4	885.0	943.1
10	928.1	938.5	901.8	838.4	921.2
15	891.1	924.5	882.1	780.3	879.6
20	829.8	899.4	855.9	712.6	814.6
25	753.7	861.8	822.4	634.8	735.7
30	663.4	806.8	781.9	546.8	643.6
35	558.1	738.1	734.7	449.6	536.2
40	442.7	657.8	682.4	347.7	418.9
45	322.4	567.3	623.8	243.4	299.6
50	204.9	466.2	560.3	143.4	181.6
55	101.4	356.7	492.9	60.86	84.70
60	27.77	244.0	420.8	10.84	16.86
65	4.112	135.5	345.9	1.668	4.051
70	2.630	47.83	268.2	1.816	2.600
75	1.706	3.690	190.8	1.167	1.677
80	1.065	1.703	117.4	0.7295	1.033
85	0.7453	18.53	49.22	0.4487	0.6440
90	29.42	53.07	1.509	0.3989	28.29
95	70.27	110.8	14.82	27.83	68.73
100	132.9	190.9	44.10	68.59	129.0
105	228.4	270.2	80.81	137.5	222.8
110	355.1	337.7	121.5	230.3	353.6
115	491.8	391.5	164.9	324.7	492.3
120	619.3	430.1	208.7	409.3	622.8
125	713.2	455.4	252.3	475.1	712.4
130	768.2	471.2	293.6	520.7	762.1
135	777.1	482.9	332.7	546.4	769.5
140	748.5	488.9	369.4	560.2	743.3
145	702.4	489.3	403.0	567.7	703.0
150	654.2	489.1	432.2	567.7	660.9
155	609.3	490.4	457.0	557.9	615.3
160	570.3	497.3	478.0	544.8	571.3
165	537.6	504.9	495.7	530.8	539.4
170	521.2	510.3	508.1	524.4	523.2
175	517.2	512.8	515.3	518.0	516.1
180	516.6	516.4	516.4	516.4	516.6
DEG	LUMINOUS INTENSITY:cd				

### Zonal Lumens

τ	φ total
0-5	22.14
5-10	87.59
10-15	193.3
15-20	334.1
20-25	503.1
25-30	691.8
30-35	890.3
35-40	1088
40-45	1275
45-50	1441
50-55	1579
55-60	1686
60-65	1763
65-70	1815
70-75	1846
75-80	1862
80-85	1868
85-90	1875
90-95	1894
95-100	1936
100-105	2010
105-110	2122
110-115	2272
115-120	2455
120-125	2661
125-130	2876
130-135	3087
135-140	3287
140-145	3468
145-150	3627
150-155	3763
155-160	3874
160-165	3960
165-170	4021
170-175	4058
175-180	4071
	UNIT: lm

### Luminance cd/(m2)

G(DEG)	C0/180	C90/270
85	119	7843
80	85	9390
75	92	10237
70	107	10891
65	135	11369
60	771	11690
55	2455	11935
50	4427	12107
45	6332	12253